



Ofi **FRAN**
MUEBLES DE OFICINA
2013 / 2014

directional **collection** direccionales
Коллекции для руководителей



ofifran

welcome to
the private offices

bienvenido a
tu oficina privada

Bienvenue aux bureaux privés

Добро пожаловать в собственный офис





sede headquarters qualite главный офис

edificio corporativo, productivo melamina y logístico: 14.000 m2
 corporate building, melamine production and logistics: 14.000 m2
 siege social, section mélamine et entrepôt: 14.000 m2
 главный офис, производство мебели из меламин и логистика: 14 000 m2



fábrica factory usine ФАБРИКА

edificio productivo madera y exposición: 11.000 m2
 building for wooden furniture production and showroom: 11.000 m2
 section ébanisterie et showroom: 11.000 m2
 производство мебели из дерева и шоу-рум: 11 000 m2

index
 índice
 СОДЕРЖАНИЕ

art&luxe	06
design by martfran	
art&moble	22
design by martfran	
prima sinfonia	48
dorigo design	
belesa	74
estellesdesign	
numen	90
design by martfran	
serena	106
estellesdesign	
concepto	122
estellesdesign	
contract	136
ray	138
dorigo design	



Passion for detail next to our highest technical requirement, characterize our directional designs, providing an appropriate aesthetics.

La pasión por el detalle, el nivel más elevado de exigencia técnica y el diseño caracterizan nuestras colecciones direccionales.

La passion du détail avec notre plus haut niveau d'exigence technique, caractérisent nos collections de direction, tout en transmettant une esthétique adéquate.

Особое внимание к деталям и высокий уровень технических требований придают кабинету руководителя эстетичный вид.

art&luxe
design by martfran

innovación desde otro punto de vista

innovation from other point of view | l'innovation depuis une autre perspective | инновации с другой точки зрения

Art&luxe es una nueva perspectiva de concebir un espacio privado. Art&luxe hace que los conceptos básicos de diseño, funcionalidad, sobriedad, elegancia,..tomen un nuevo sentido al conjugarlos con una insistencia del cuidado de la calidad y el gusto por los detalles que nos ha llevado a perfilar con esmero todos los elementos que componen la colección.

Art & luxe, a new perspective to design a private space. Art & luxe uses the basic concepts of design, functionality, simplicity, elegance, .. combined with our adherence to quality of care and our attention to detail has compelled our craftsmen to lovingly create each element of the collection.

Art&luxe est une nouvelle manière de concevoir l'espace privé. Art&luxe fait prendre une nouvelle direction aux concepts de base de conception, fonctionnalité, sobriété, élégance,... en mettant l'accent sur la qualité et en prêtant une attention particulière aux détails, ce qui nous amène à affiner avec soin tous les éléments de la collection.

Art&Luxe – новый взгляд на создание персональных пространств. Art&Luxe придает основным концепциям дизайна, функциональности, строгости, элегантности новый смысл в сочетании с заботой о качестве и любовью к деталям, что побудило нас внимательно относиться к созданию всех элементов, которые составляют эту коллекцию.









exclusive selection
exclusiva selección
sélection exclusive
ЭКСКЛЮЗИВНЫЙ ВЫБОР





prestige and tradition
prestigio y tradición
prestige et tradition
престиж и традиции





harmony in every detail
armonía en cada detalle
harmonie dans le moindre détail
гармония в каждой детали



mesas de dirección

directional desks
bureaux de direction
столы для руководителя



01121LX
2200x900x780

faldones

modesty panels
voile de fond
панели передние



01128LX
910x35x620

sillas y sillones

chairs & armchairs
fauteuils
кресла и стулья



01002LX
630x680x1070



01003LX-G
630x680x980



01003LX-F
630x680x980

sofás

sofas
sofas
диваны



01006
930x850x740



01007
1580x850x740



01008
2050x850x740



01009
1050x850x750



01010
1600x850x750



01011
2100x850x750

mesas de juntas

meeting tables
tables de réunion
столы для совещаний



01133LX
3200x1200x780



01134LX
1200x900x780

auxiliares

pedestals & auxiliary
éléments auxiliaires
дополнительные
элементы мебели



01127LX
1100x600x780



01144LX
890x585x875

mesas de centro

coffee tables
tables basses
столы журнальные



01118LX
1100x1000x470



01119LX
700x700x600

aparadores

sideboards
buffet
шкафы низкие



01164LX
2200x525x950

artículos según medida cliente

items as per customers measurements
-
специзделия по размерам клиента

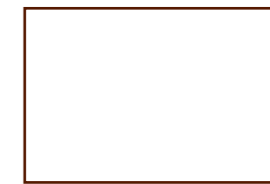

LX99991

librerías modulares

modular bookcases
corps bibliothèque
шкафы модульные



01170LX
660x335x2045



01171LX
965x335x2045



01171ROLX
965x335x2045



01251LX
1650x335x2045

paneles

wall panels
panneaux muraux
панелирование – стеновые панели



LX99993

según proyecto
per project
sur demande
по проекту

puertas

doors
portes
двери



01180LX
600x621



01181LX
905x621



01182LX
905x1300



01183LX
905x1300



01184LX
905x1950



01185LX
600x1300

componentes librero 2200 mm

bookcase components
éléments bibliothèque
составные части шкафов 2200 мм



unidad | unit | unité | единица измерения >> mm

opciones de superficie surface options | finitions | варианты отделки

art&lux

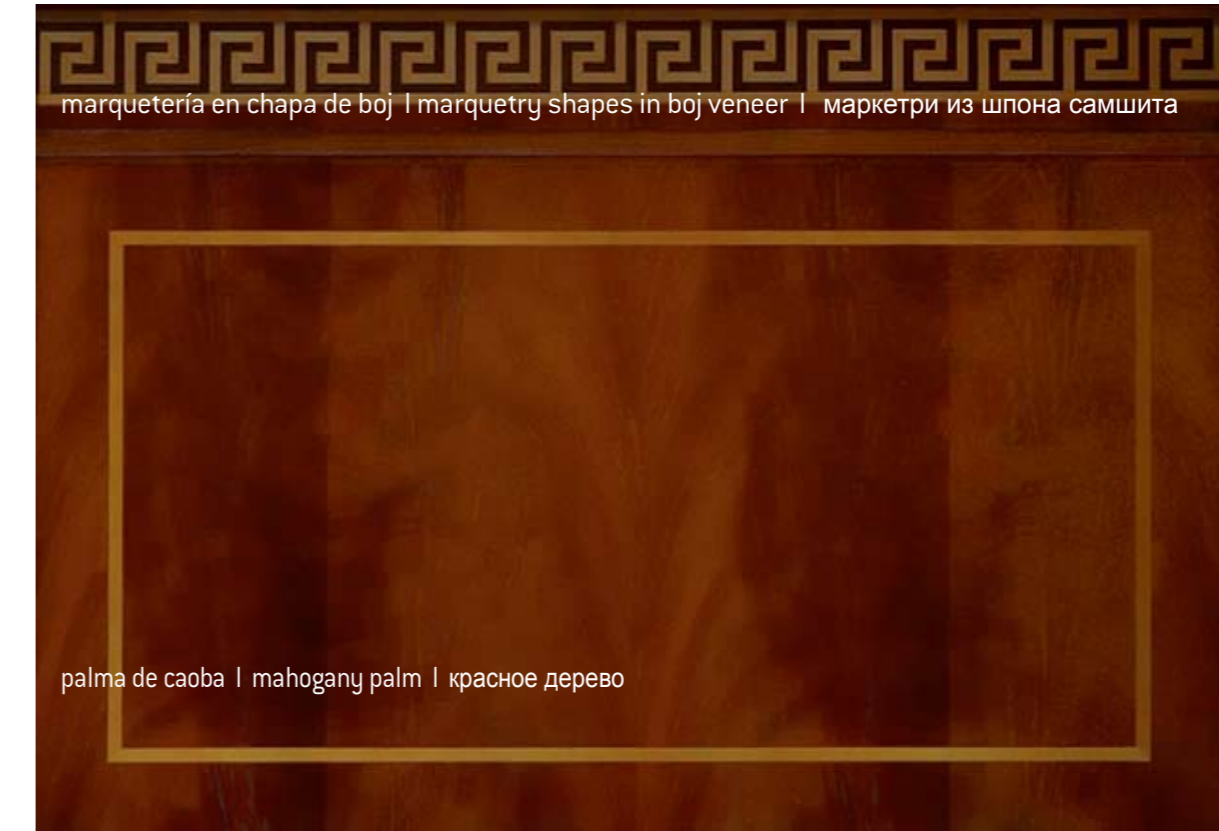

Datos técnicos Technical data
Fiche technique | Технические данные

Tableros de 19 a 30 mm de espesor, recubiertos con chapa natural de palma de caoba, con incrustaciones de formas geométricas de chapa de boj.

Molduras y macizos de madera de sapeli.

19 to 30 mm thick panels, finished in natural mahogany palm veneer with inlaid geometric patterns finished in box veneer.

Mouldings and edges in solid sapelly wood.

Panneaux de 19 à 30 mm d'épaisseur, recouverts d'un placage naturel d'acajou, avec des incrustations en formes géométriques de placage de buis.

Moultures et bois massif de sapelli.

Плиты толщиной 19-30 мм, покрытые шпоном красного дерева с инкрустацией из самшита, повторяющей рисунок меандра.

Молдинги и кромки из массива сапели.

Acabado Finish
Finition | отделка

Capa de imprimación, 2 capas de fondo poliacrílico y 1 capa de laca de poliuretano.

Conditioner coat, 2 polycrylic base coats and 1 polyurethane finish coat.

1 couche d'imprimation, 2 couches de fond poli-acrylique, 1 couche de fond de laque de poliuréthane.

2 слоя полиакрилового лака, 1 слой износостойчивого полиуретанового лака

Acabado piel página 47

Leather finishes page 47

Finition cuir page 47

варианты отделки кожи стр. 47

art&moble
design by martfran

un mundo de tradición

a world of tradition | un monde de tradition | Мир традиций

La colección de Art&moble se considera como una selección de productos que han perdurado a lo largo de los años y que forman parte de nuestra historia. Un clásico de la marca Ofifran con elegante personalidad.

Art&Moble collection is considered a selection of finest products, that have endured over the years and remains a part of our history. A classic design from Ofifran, with stylish and elegant personality.

La colección Art&Moble se considère comme une sélection de produits qui ont subsistés au cours des années et qui font partie intégrante de notre histoire. Un classique de Ofifran avec une élégante personnalité.

Серия Art&Moble рассматривается как особая коллекция, востребованная в течение многих лет, и составляет часть нашей истории. Art&Moble – классический стиль, придающий элегантность и персональность, подчеркивающий бренд Ofifran.





richness in details
riqueza en detalles
richesse des détails
богатство деталей











a world of tradition
un mundo de tradición
un monde de tradition
мир традиций



we take care of details
cuidamos los detalles
nous soignons les détails
внимание к деталям







essence
esencia
essence
сущность



opciones de superficie surface options | finitions | варианты отделки

CEREZO (CZ)



Datos técnicos Technical data
Fiche technique | Технические данные

Tablero de aglomerado de 19 a 25 mm. chapado en chapa natural de cerezo y raíz de fresno olivato. Moldura y macizos de madera de haya .
19mm. and 30mm. thick board
Veneered with 0,6mm. thick wooden veneer
Plateau aggloméré de 19 a 25mm, plaquage naturel de cerisier et de frêne d'olivier.
Moulures et massifs d'hêtre.
Плиты ДСП толщиной 19-25 мм, покрытые натуральным шпоном черешни и корня оливкового ясеня. Молдинги и кромки из массива бука.

Acabado Finish
Finition | отделка

Capa de imprimación, 2 capas de fondo poliacrílico y 1 capa de laca de poliuretano.
Conditioner coat, 2 polycrylic base coats and 1 polyurethane finish coat.
1 couche d'imprimación, 2 couches de fond poli-acrylique,
1 couche de fond de laque de poliuréthane.
2 слоя полиакрилового лака , 1 слой износостойчивого полиуретанового лака

opciones de superficie - proyectos surface options - projects | finitions - projects | варианты отделки - проекты

CEREZO | CHERRY (CZ)
CERISIER | ЧЕРЕШНЯ



NOGAL | WALNUT (NA)
NOYER | ОРЕХ



NEGRO | BLACK (NT)
NOIR | ЧЕРНЫЙ | ГРАФИТ



NOGAL ITALIANO | ITALIAN WALNUT (NI)
NOYER ITALIEN | ИТАЛЬЯНСКИЙ ОРЕХ



WENGUÉ | WENGUE (WE)
WENGÉ | ВЕНГЕ



* ACABADO CLIENTE | CUSTOMER'S CHOICE (AC)
CLIENT FINAL | ПО ОБРАЗЦУ КЛИЕНТА



mesas de dirección

directional desks
bureaux de direction
столы для руководителя



01101
2500x1900x780



01102
2500x1900x780



01137
2500x2500x750



01131
1300x1300x750



01236
1650x1100x750



01132
2500x1200x750

mesas de juntas

meeting tables
tables de réunion
столы для совещаний



01133
3200x1200x750

faldones

modesty panels
voile de fond
панели передние



01128
960x35x600



01129
760x35x600



01134
900x1200x750

alas

extensions
retour
столы приставные

mesas

desks
bureaux
столы



01121
2000x900x750



01122
1800x900x750



01136
1800x900x750



01123
1400x700x750



01124
1200x600x750



01125
1600x800x750

mesas de centro

coffee tables
tables basses
столы журнальные



01117
1300x700x450



01118
1000x1000x450



01119
700x700x550



01242
600x600x800



01243
600x600x1100

auxiliares

pedestals & auxiliary
éléments auxiliaires
дополнительные
элементы мебели



01127
1120x620x750



01142
700x450x810



01233
800x600x750



01126
800x600x750



01140
530x580x1330



01143
530x580x750



01144
775x560x820

mueble TV

cabinet TV
meuble TV
шкаф низкий под ТВ с подъемным механизмом



01160
1200x365x910



01162
2000x400x750



01163
1550x400x830



01234
1675x505x920



01235
2450x505x920



01161
1550x400x750

aparadores

sideboards
buffet
шкафы низкие

sillas y sillones

chairs & armchairs
fauteuils
кресла и стулья



01001
700x800x1160



01012
700x800x1160



01013
700x800x950



01002
580x580x1100



01003
580x580x1030



01004
450x450x950



01005
450x450x950

sofás

sofas
sofas
диваны



01006
930x850x740



01007
1580x850x740



01008
2050x850x740



01009
1050x850x750



01010
1600x850x750



01011
2100x850x750

complementos

complements
compléments
вспомогательные элементы



01230
1300x350x920



01231
1150x1200



01232
1600x400x920



01238
1110x615x1410



01239
1110x615x1410



01241
1215x495x2220



01245
1075x540x1195

paneles

wall panels
panneaux muraux
панелирование – стеновые панели



01145
320x320x455



01146
620x320x455



01148
300x300x900



01149
300x300x1200



01150
300x300x600



AM99993

según proyecto
per project
sur demande
по проекту

libreros modulares

modular bookcases
corps bibliothèque
шкафы модульные



01170
660x333x2000



01171
965x333x2000



01171R0
965x333x2000



01250
1300x333x2000



01251
1600x333x2000

puertas

doors
portes
двери



01180
598x623



01181
904x623



01182
904x1252



01183
904x1252



01184
904x1887

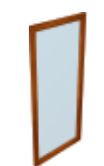

01185
660x1252

componentes librero 2200 mm

bookcase components
éléments bibliothèque
составные части шкафов 2200 мм

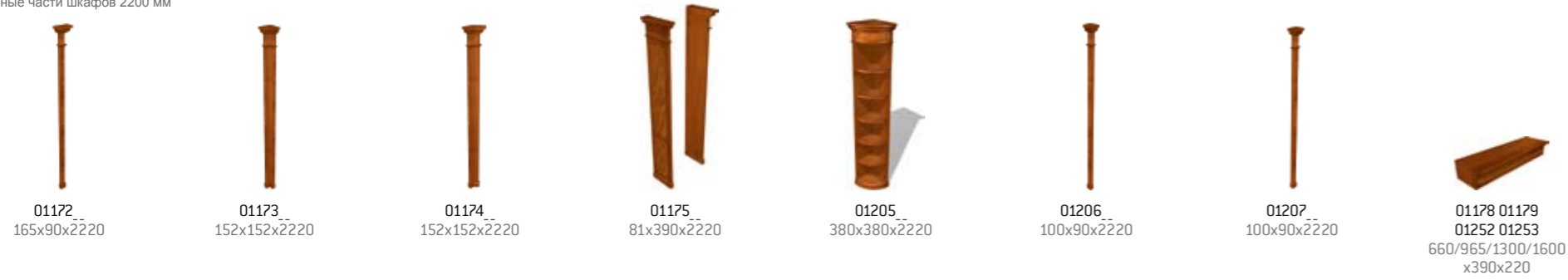

componentes librero 2500 mm

bookcase components
éléments bibliothèque
составные части шкафов 2500 мм



vades

table pad
-
бювары

artículos según medida cliente

items as per customers measurements
-
специзделия по размерам клиента

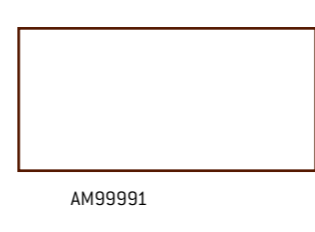

opciones de tapizado leather finishes | finitions | варианты обивки

PIEL MARRÓN OSCURO | DARK BROWN LEATHER (06)
CUIR MARRON FONCÉ | КОЖА ТЕМНО-КОРИЧНЕВАЯ



PIEL MARRÓN CLARO | LIGHT BROWN LEATHER (02)
CUIR MARRON CLAIR | КОЖА СВЕТЛО-КОРИЧНЕВАЯ



PIEL BLANCA | WHITE LEATHER (07)
CUIR BLANC | КОЖА БЕЛАЯ

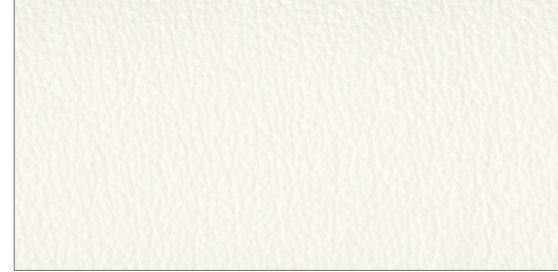

PIEL MAFIL | IVORY LEATHER (04)
CUIR IVOIRE | КОЖА – СЛОНОВАЯ КОСТЬ



PIEL VERDE | GREEN LEATHER (00)
CUIR VERT | КОЖА ЗЕЛЕНАЯ



PIEL NEGRA | BLACK LEATHER (01)
CUIR NOIR | КОЖА ЧЕРНАЯ



PIEL GRIS PIEDRA | STONE GREY LEATHER (09)
CUIR GRIS | КОЖА СЕРАЯ - ТОРТОЛА



PIEL ANTRACITA | ANTHRACITE LEATHER (08)
CUIR ANTHRACITE | КОЖА АНТРАЦИТ



PIEL GRIS | GREY LEATHER (11)
CUIR GRIS | КОЖА СЕРАЯ



PIEL ROJO | RED LEATHER (05)
CUIR RED | КОЖА КРАСНАЯ



prima sinfonia
dorigo design

espíritu vanguardista, contemporáneo

avant-grade, contemporary spirit | esprit d'avant-grade, contemporain
дух авангарда и современности

Diseño a temporal, nuevas formas y nuevos conceptos para el mueble de oficina actual. EL placer de crear la combinación perfecta entre diferentes materiales y la tecnología mas alta. Cromo, madera natural, cristal y piel se utilizan para crear esta colección hecha de detalles, rica en todas sus formas y rincones. Mas de 40 elementos impactantes y elegantes permiten a Prima sinfonia ofrecer infinitas soluciones para cualquier necesidad en el mercado contract. Con un diseño vanguardista y espíritu contemporáneo, ha sido diseñada para durar en el tiempo.

Untemporal design, new shapes, new concepts for the office furniture environment. The pleasure of creating the perfect combination between different materials and highest technology. Chrome, wood veneer, glass and leather are used to create this collection made of details, rich in all its corners and shapes. More than 40 impacting and distinguished pieces make Prima Sinfonia a suitable collection for many purposes in the contract market. With an Avant-garde and contemporary spirit, it has been designed to last in time.

Temps de conception, de nouvelles formes et de nouveaux concepts pour le mobilier de bureau moderne. Le plaisir de créer la combinaison parfaite de matériaux différents et plus de technologie. Chrome, bois naturel, verre et cuir sont utilisés pour créer cette collection fait de détails, riche en toutes ses formes et les coins. Plus de 40 éléments permettent frappantes et élégant offrant une infinité de solutions symphoniques Prima pour tous les besoins dans le contrat de marché. Avec un design moderne et contemporain, conçu pour durer dans le temps.

Вневременной дизайн, новые формы и новые концепции для современной офисной мебели. Удовольствие создавать идеальные сочетания из различных материалов и высоких технологий. Хром, натуральный шпон, стекло и кожа используются при создании этой коллекции, наполненной деталями и отличающейся богатыми формами. Более 40 поражающих элегантною элементов коллекции

Prima sinfonia позволяют предложить бесконечные варианты решений для любых потребностей «contract market». Авангардный дизайн и современный стиль не подвластный времени.



the pleasure of design
el placer del diseño
le plaisir du design
наслаждение дизайном



untemporal design
diseño intemporal
design intemporel
вневременной дизайн





aesthetics and elegance
estética y elegancia adecuada
esthétique et élégance
эстетика и элегантность







essence
esencia
essence
суцність





mesas de dirección

directional desks
bureaux de direction
столы для руководителя



PSCC01501 1900x1000x750



PSMM01500 2100x900x750
PSMM01501 1900x900x750



PSMC01500 2100x900x750
PSMC01501 1900x900x750



PSMP01500 2100x900x750
PSMP01501 1900x900x750



PSMM01502 2365x900x750
PSMM01503 2165x900x750



PSMC01502 2365x900x750
PSMC01503 2165x900x750



PSMP01502 2365x900x750
PSMP01503 2165x900x750



PSMM01508 2630x900x750
PSMM01509 2440x900x750



PSMC01504 2540x1520x750
PSMC01505 2340x1520x750



PSMP01504 2540x1520x750
PSMP01505 2340x1520x750

auxiliares

pedestals & auxiliary
éléments auxiliaires
дополнительные
элементы мебели



PSMM01506 2500x2400x750



PSMM01507 2500x2400x750

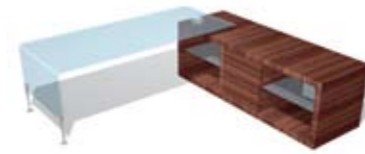

PSMC01506 2500x2400x750

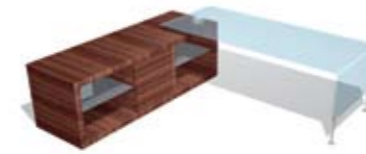

PSMC01507 2500x2400x750



PSFC01500 1920x10x318
PSFC01501 1720x10x318



PSMM01510 1200x600x750



PSMM01518 1200x700x750



PSMM01523 550x450x620



PSMM01524 550x450x620



PSMM01525 900x450x750

mesas de juntas

meeting tables
tables de réunion
столы для совещаний



PSMM01530 2200x1200x750



PSMM01534 1400x1200x750



PSMM01531 3600x1200x750



PSMC01530 2200x1200x750



PSMC01534 1400x1200x750



PSMC01531 3600x1200x750

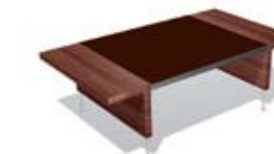

PSMP01530 2200x1200x750

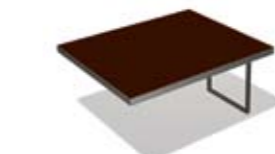

PSMP01534 1400x1200x750



PSMP01531 3600x1200x750

mesas de juntas

meeting tables
tables de réunion
столы для совещаний



PSM01532___ 2200x1500x750



PSM01535 1400x1500x750



PSM01533 3600x1500x750



PSMC01532 2200x1500x750

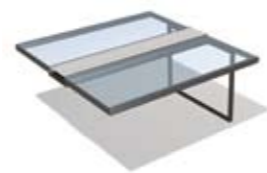

PSMC01535 1400x1500x750



PSMC01533 3600x1500x750



PSMP01532 2200x1500x750

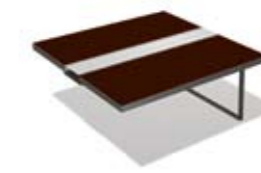

PSMP01535 1400x1500x750



PSMP01533 3600x1500x750



PSM01515___ d1600x750
PSM01516___ d1300x750



PSMC01515___ d1600x750
PSMC01516___ d1300x750



PSMP01515___ d1600x750
PSMP01516___ d1300x750

puertas correderas

doors
portes coulissantes
Раздвижные двери



PSPM01591___ 920 x 50 x 1322



PSPM01592___ 920 x 50 x 424



PSPC01591___ 950 x 100 x 1322



PSPC01592___ 950 x 100 x 424



PSPC01591MR___ 920 x 50 x 1322



PSPC01592MR___ 920 x 50 x 424

estanterías

wall shelving
étagères murales
стеллажи



PSMA01581___ 1896x430x900



PSMA01582___ 2794x430x900



PSMA01585___ 1896x430x1797



PSMA01586___ 2794x430x1797

armarios

bookcases
armoires
шкафы



__01331 930x420x690 __01332 930x420x1330 __01333 930x420x2000 __01341 465x420x690 __01342 465x420x1330

puertas

doors
portes
двери



01343 465x420x2000 __01335 920x20x630 01335-1 460x20x630 01336 920x20x1260 01336-1 460x20x1260

tapas

tops
dessus armoires
топы для шкафов



__01354 17x450x707 __01355 17x450x1347 __01356 17x450x2017
 __01366 965x450x17 __01367 1895x450x17 __01368 2825x450x17 __01369 1430x450x17 __01370 2360x450x17
 BST900 890x375 PS99991

articulos según medida cliente

items as per customers measurements
-
специзделия по размерам клиента

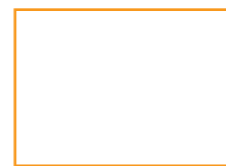

PS99991

panel separador de sofa

sofa partition
cloison pour sofa
панели разделительные для диванов



PSSC01577TR/BL 580x10x480
 PSSC01578TR/BL 1180x10x480
 PSSC01579TR/BL 1780x10x480

mesas de centro

coffee tables
tables basses
столы журнальные



__PSMM01545 900x900x320



__PSMM01546 1200x600x320

aparador

sideboard
buffet
приставной модуль



PSMM01527__BL/TR 2100x700x690

mueble bar

bar cabinet
meuble bar
фригобар



PSMM01526__BL/TR 970 x 550 x 760

sofás

sofas
sofas
диваны



PSPI01571__ 960x795x725 PSPI01572__ 1560x795x725 PSPI01573__ 2160x795x725 PSPI01574__ 960x1660x725 PSPI01575__ 1560x1660x725

sillas

seating
fauteuils
кресла



PSPI01576 2160x1660x725



PAD501P4C8 700 x 700 x 1270



PAV50200CO 580x700x955



VIVOS11D00 595x570x840



VIMOS13D10 595x555x840

opciones de superficie | surface options | finitions | варианты отделки

TEKA OSCURO | DARK TEAK (TK)
TEAK FONCÉ | ТЕКА ТЕМНЫЙ



TEKA NEGRO | BLACK TEAK (TB)
TEAK NOIR | ТЕКА ЧЕРНЫЙ



TEKA WENGUÉ | WENGUE TEAK (TW)
TEAK WENGÉ | ТЕКА ВЕНГЕ



LACADO BLANCO MATE | MATE WHITE LACQUERED (LB)
BLANC LAQUE MATE | БЕЛЫЙ – ЛАКИРОВАННЫЙ МАТОВЫЙ

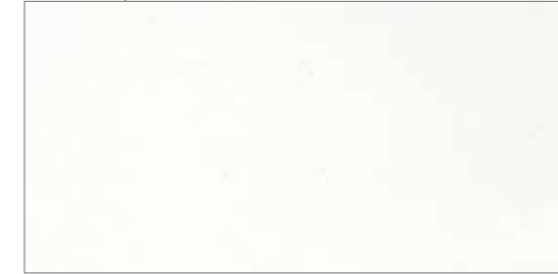

LACADO GRIS PIEDRA | STONE GREY LACQUERED (LG)
GRIS LAQUE MATE | СЕРЫЙ ТОРТОЛА – ЛАКИРОВАННЫЙ МАТОВЫЙ

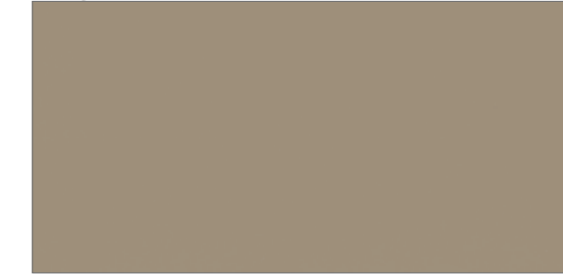

LACADO ANTRACITA MATE | MATE ANTHRACITE LACQUERED (LA)
ANTHRACITE LAQUE MATE | АНТРАЦИТ – ЛАКИРОВАННЫЙ МАТОВЫЙ



CRISTAL TRANSPARENTE | TRANSPARENT GLASS (TR)
VERRE TRANSPARENT | СТЕКЛО ПРОЗРАЧНОЕ

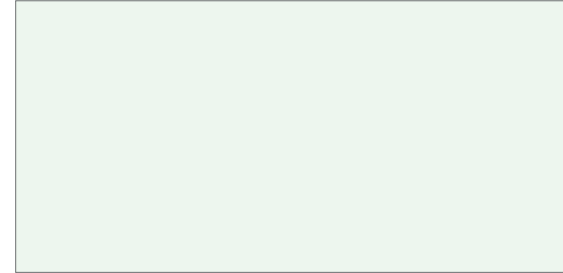

CRISTAL ÓPTICO LACADO BLANCO | WHITE LACQUERED OPTICAL GLASS (BL)
VERRE OPTIQUE LAQUÉ BLANC
СТЕКЛО БЕЛОЕ ЛАКИРОВАННОЕ

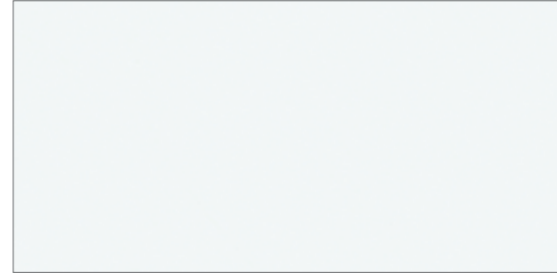

LACADO MARRÓN MATE | MATE BROWN LACQUERED (LM)
MARRON LAQUE MATE | КОРИЧНЕВЫЙ – ЛАКИРОВАННЫЙ МАТОВЫЙ



Datos técnicos | Technical data

Fiche technique | Технические данные

Tablero DM y AG atamborado 60mm. de espesor.

Chapado con chapa de madera de teka 0,6mm. de espesor.

Vidrio transparente o translúcido de 10 mm.

MDF, particle board and technical sandwich board 60mm thick

Veneered with 0,6mm thick teak wooden veneer

transparent or translucent 10mm glass

Plateau: DM, aggloméré et rembourré de 60mm d'épaisseur

Plaquage bois naturel de 0,6mm d'épaisseur

Verre transparent ou translucide de 10mm.

Тамборат МДФ и ДСП толщиной 60 мм.

Покрытие натуральным шпоном тека толщиной 0,6 мм.

Прозрачное или полупрозрачное стекло 10 мм.

Acabado | Finish

Finition | отделка

2 capas de fondo poliacrílico y 1 capa de laca de poliuretano.

Conditioner coat, 2 polyacrylic base coats and 1 polyurethane finish coat.

2 couches de fond poli-acrylique, 1 couche de fond de laque de poliuréthane.

2 внутренних слоя из полиакрила и 1 слой из полиуретанового лака

Acabado piel | página 47

Leather finishes | page 47

Finition cuir | page 47

варианты отделки | кожа | стр. 47

elementos distintivos y de impacto

impacting and distinguishing elements | éléments distinctifs et d'impact
отличительные и характерные элементы

Exigente y dinámica, con un diseño muy simple y limpio, pero al mismo tiempo capaz de proporcionar elegancia y fuerza. Personalizable en diferentes acabados, se puede adaptar al cliente más clásico, con su versión en madera o bien dar soluciones al más moderno debido a su versión lacada. 5 acabados diferentes para combinaciones infinitas.

Dinamic and exigent, with a very simple and clean design, but at the same time able to provide elegance and strength. Customizable in different finishes, from the most classic design in its wooden version to the most modern option in lacquered finishes. 5 different finishes for infinite possibilities.

Exigeant et dynamique, avec une élégance très simple et propre, mais aussi en mesure de fournir et de la force. Personnalisable dans différentes finitions peuvent être adaptés à la clientèle plus classique, avec sa version en bois ou apporter des solutions à plus moderne grâce à sa version laquée. 5 couleurs différentes pour des combinaisons infinies.

Требовательная и динамичная, с простым и чистым дизайном эта коллекция в то же время отличается элегантностью и силой. Благодаря различным видам отделки, ее можно адаптировать для клиентов, предпочитающих классический стиль, выбрав шпон или предоставить более современное решение в лаковой отделке. 5 видов отделки позволяют создавать множество комбинаций.





elegance
elegancia destacable
remarquable élégance
Характерная элегантность



an exigency, a distinguishing sign
una exigencia un signo distintivo
une exigence, un signe distinctif
требовательность, отличительный знак





lightness
ligereza
légèreté
легкость







mesas de dirección

directional desks
bureaux de direction
столы для руководителя



BE01300 2100x1000x770

mesas de juntas

meeting tables
tables de réunion
столы для совещаний



BE01315 1300x1300x770



BE01316 2400x1200x770

mesas auxiliares

auxiliary tables
tables auxiliaires
столы вспомогательные



BE01310 1200x600x770
BE01311 1200x600x770

mesas de centro

coffee tables
tables basses
столы журнальные



BE01348 700x700x470

mueble bar

bar cabinet
meuble bar
фригобар



BE01346 855x500x785



BE01324 450x560x620

faldones

modesty panels
voile de fond
панели передние

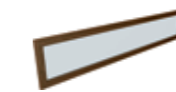

BE01306 1900x355

soportes CPU

CPU supports
supports UC
опора для системного блока



BE01312 280x500x550

panel

screen
cloisonette
панели разделительные



BE99993 según proyecto
per project
sur demande
по проекту

armarios

bookcases
armoires
шкафы



_01331 930x420x690



_01332 930x420x1330



_01333 930x420x2000



_01341 465x420x690



_BE01345 375x460x630

tapas

tops
dessus armoires
топы для шкафов



01342 465x420x1330



01343 465x420x2000



_01366 965x450x17
_01367 1895x450x17
_01368 2825x450x17
_01369 1430x450x17
_01370 2360x450x17



_01361 1090x450x80
_01362 2020x450x80
_01363 2950x450x80
_01364 1555x450x80
_01365 2485x450x80



BST900 890x375

archivo

filings
classement
архив

artículos según medida cliente

items as per customers measurements
-
специзделия по размерам клиента

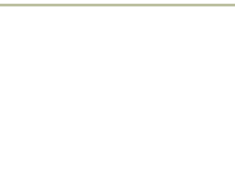

BE99991

puertas

doors
portes
двери



_01335 920x20x630



_01335-1 460x20x630



_01336 920x20x1260



_01336-1 460x20x1260



_01337 920x20x630



_01337-1 460x20x630



_01338 920x20x1260



_01338-1 460x20x1260



_01354 17x450x707
_01355 17x450x1347
_01356 17x450x2017



_01351 80x450x770
_01352 80x450x1410
_01353 80x450x2080

juego de costados finales para armarios

set of bookcases endsides
jeu de panneaux latéraux
боковины шкафов

opciones de estructura structure options | finitions | варианты отделки каркаса

ROBLE | OAK (RO)
CHÊNE | ДУБ



WENGUÉ | WENGUE (WE)
WENGÉ | ВЕНГЕ



NOGAL | WALNUT (NA)
NOYER | ОРЕХ



LACADO BLANCO BRILLO | WHITE GLOSS LACQUER (BB)
LAQUÉ BLANC BRILLANT | ПОКРЫТИЕ БЛЕСТЯЩИМ БЕЛЫМ ЛАКОМ



ROBLE NEGRO | OAK BLACK (NP)
CHÊNE-NOIR | ДУБ-ЧЕРНЫЙ



Datos técnicos Technical data
Fiche technique | Технические данные

Tablero atamborado 100mm. y 80mm. de espesor.
Chapado con chapa de madera de roble 0,6 mm. de espesor.
100mm. and 80mm. thick board on frame construction.
Veneered with 0,6mm. thick wooden veneer oak.
Plateau rembourré 100mm et 80mm d'épaisseur.
Plaquage bois naturel de 0,6mm d'épaisseur.
Тамборат толщиной 100 мм и 80 мм
Покрытие натуральным шпоном дуба или венге толщиной 0,6 мм

Acabado Finish
Finition | отделка

Capa de imprimación, 2 capas de fondo
poliacrílico y 1 capa de laca de poliuretano.
Conditioner coat, 2 polycrylic base coats and 1
polyurethane finish coat.
1 couche d'imprimation, 2 couches de fond poli-acrylique,
1 couche de fond de laque de poliuréthane.
2 слоя акрилового лака , 1 слой
износоустойчивого полиуретанового лака

el sentido del detalle

sense of detail | le sens du détail | чувство деталей

Colección direccional en madera natural y cantos postformados. La serenidad en sus formas permite crear elegantes y confortables ambientes de trabajo. Tiene unas líneas suaves y ligeras, Numen esta disponible en 7 acabados diferentes. También incluye una gama amplia de piezas adicionales, como sofás, mesas de centro y mesa de juntas modular.

Executive collection in wood veneer and postformed edges. The serenity in its shapes permits to create elegant and comfortable atmospheres. With soft and light shapes and available in seven different colours, Numen is a collection that also includes a range of complementary pieces, like armchairs, coffee tables and modular meeting desks.

Exécutif dans la collecte des bois de placage et des bords postformés. La sérénité en matière de STI permet de créer des formes élégantes et des atmosphères confortables. Avec des formes douces et légères et disponibles en 7 couleurs différentes, Numen est une collection qui comprend également un éventail de pièces complémentaires, comme des fauteuils, tables basses et des bureaux de réunion modulaire.

Коллекция для руководителей из натурального шпона с мягкими, округлыми формами. Коллекция Numen с легкими и плавными линиями представлена в 7 видах отделки. Также предлагается широкая гамма дополнительных комплектующих элементов, таких как диваны, журнальные столы и модульные столы для совещаний.

numen
design by MartFran









strong corporeity
fuerte materialidad
forte matérialité
прочность

contemporary style
estilo contemporáneo
style contemporain
современный стиль



mesas de dirección

directional desks
bureaux de direction
столы для руководителя



__01600__ 2100x960x750
__01601__ 1900x960x750



__01602__ 2780x1400/900x750



__01603__ 2780x1400/900x750



__01605__ 2300x1100x750



__01615__ d1250x750

mesas de juntas

meeting tables
tables de réunion
столы для совещаний



__01616__ 2430x1200x750
__01617__ 3000x1200x750



__01647__ 3200x1600x750
__01647CR__ 3200x1600x750



__01648__ 4800x1600x750
__01648CR__ 4800x1600x750



__01645__ 800x800x470



__01646__ 1300x700x470

mesas de centro

coffee tables
tables basses
столы журнальные

alas

extensions
retour
столы приставные



__01610__ 1200x550x750



__01612__ d1200x750



__01618__ 1400x700x750



__01619__ 1400x700x750



__01622__ 330x430x715

soportes CPU

CPU supports
supports UC
опора для системного блока

mesas auxiliares

auxiliary tables
tables auxiliaires
столы вспомогательные



__01613__ 720x430x100



__01611__ 1200x600x750



AUX7000125 235x140x40

sofás

sofas
sofas
диваны



__01671PI__ 920x800x960



__01672PI__ 1600x800x960



__01673PI__ 2235x800x960

auxiliares

pedestals & auxiliary
éléments auxiliaires
дополнительные
элементы мебели



__01625__ 1200x600x595



__01642__ 750x460x740



__01621__ 430x520x325



__01623__ 475x530x595



__01624__ 475x530x595

armarios
bookcases
armoires
шкафы



tapas
tops
dessus armoires
топы для шкафов



puertas
doors
portes
двери

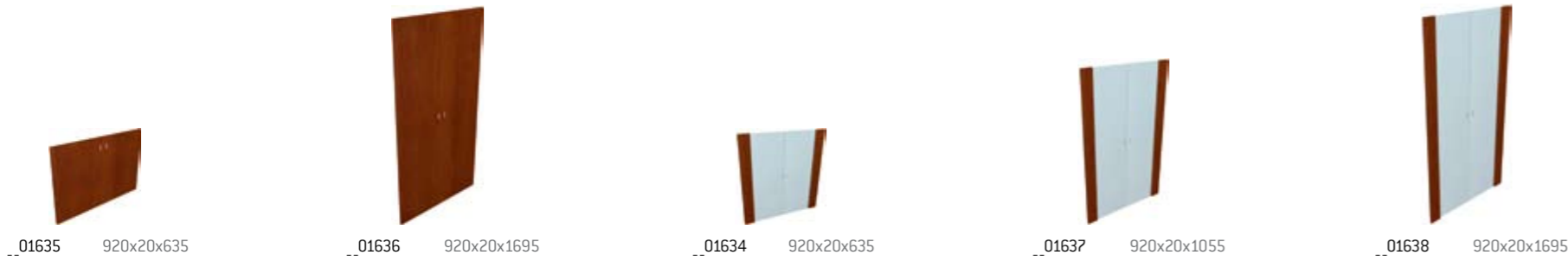

juego de costados finales para armarios
set of bookcases endsides
jeu de panneaux latéraux
боковины шкафов



paneles
wall panels
panneaux muraux
панелирование – стеновые панели



artículos según medida cliente
items as per customers measurements
-
специзделия по размерам клиента

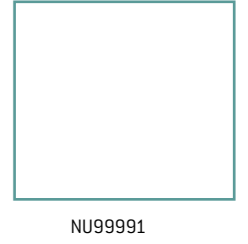

elementos de archivo para armario
filing elements for bookcases
éléments pour corps d'armoire
составные части для шкафа



estanterías
wall shelving
étagères murales
стеллажи



opciones de superficie surface options | finitions | варианты отделки

NOGAL ITALIANO | ITALIAN WALNUT (NI)
NOYER ITALIEN | ИТАЛЬЯНСКИЙ ОРЕХ



NOGAL ESPAÑOL | SPANISH WALNUT (NE)
NOYER ESPAÑOL | ИСПАНСКИЙ ОРЕХ



NEGRO TINTADO | BLACK TINTED (NT)
TEINTÉ NOIR | ТОНИРОВКА ЧЕРНЫМ ЦВЕТОМ



LACADO BLANCO MATE | MATE WHITE LACQUERED (LB)
BLANC LAQUE MATE | БЕЛЫЙ – ЛАКИРОВАННЫЙ МАТОВЫЙ



LACADO ANTRACITA MATE | MATE ANTHRACITE LACQUERED (LA)
ANTHRACITE LAQUE MATE | АНТРАЦИТ – ЛАКИРОВАННЫЙ МАТОВЫЙ



LACADO GRIS PIEDRA | STONE GREY LACQUERED (LG)
GRIS LAQUE MATE | СЕРЫЙ ТОРТОЛА – ЛАКИРОВАННЫЙ МАТОВЫЙ



WENGUÉ | WENGUE (NW)
WENGÉ | ВЕНГЕ



LACADO MARRÓN MATE | MATE BROWN LACQUERED (LM)
MARRON LAQUE MATE | КОРИЧНЕВЫЙ – ЛАКИРОВАННЫЙ МАТОВЫЙ

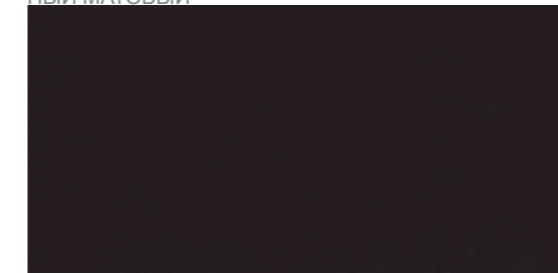

Datos técnicos Technical data
Fiche technique | Технические данные

Tapas: Tableros de fibra de densidad media (mdf) de 19mm. a 30mm.
Pies: Panel atamborado en chapa natural de madera 0,6mm.
19mm. to 30mm. thick mdf board
Veneered with 0,6mm. thick wooden veneer
Plateau DM de 19 a 30mm.
Plaquage naturel 06mm.
Столешницы: МДФ 19-30 мм.
Опоры: Тамборат с покрытием натуральным шпоном 0,6 мм.

Acabado Finish
Finition | отделка

Capa de imprimación, 2 capas de fondo
poliacrílico y 1 capa de laca de poliuretano.
Conditioner coat, 2 polycrylic base coats and 1
polyurethane finish coat.
1 couche d'imprimation, 2 couches de fond poli-acrylique,
1 couche de fond de laque de poliuréthane.
2 слоя акрилового лака , 1 слой
износоустойчивого полиуретанового лака

Acabado piel página 47
Leather finishes page 47
Finition cuir page 47
варианты отделки кожи стр. 47

personal y con personalidad

personal and with personality | personnel et avec personnalité | индивидуальность и отличительный характер

Colección direccional en madera natural, disponible en 8 acabados diferentes y combinables entre sí. Formas rectas en sus encimeras de mesa combinadas las formas curvas de sus laterales son la característica principal de esta línea elegante y cálida. Mobiliario con un estilo propio de gran diseño y calidad.

Directional collection in natural wood, available in 8 different finishes allowing the combination of colours. Straight shape of their tops combined with curved legs is the main feature of this elegant and warm collection. Stylish furniture with a great design and quality.

Directionnelle collection en bois naturel, disponible en 8 finitions différentes et combinables entre eux. Formes droites dans leurs comptoirs de Bureau combiné les courbes de ses côtés sont la principale caractéristique de cette ligne élégante et chaleureuse. Meubles avec un style très design et de qualité.

Коллекция для руководителей из натурального шпона представлена в 8 различных видах отделки, которые комбинируются между собой. Сочетание прямых линий столешницы и округлых боковых частей являются основной особенностью этой элегантной и теплой коллекции. Мебель неповторимого стиля и высокого качества.

serena
estellesdesign







power and temperament
energía y temperamento
tempérament et puissance
сила и характер





brilliant personality
gran personalidad
grand personnalité
Индивидуальный характер



mesas ejecutivas

executive desks
bureaux semi-directionnels
столы для руководителя



SE01700 2120x900x750
SE01701 1920x900x750
SE01702 1720x900x750



SE01705 2120x2100x750
SE01706 1920x2100x750
SE01707 1720x2100x750



SE01715 1200x1200x750



SE01716 2000x1200x750
SE01717 2400x1200x750



SE01718 3200x1200x750
SE01719 3600x1200x750
SE01720 4000x1200x750

centros

coffee tables
tables basses
столы журнальные



SE01745 810x700x470



SE01746 1510x700x470



SE01711 1320x600x750



AUX7000125 235x140x40

mesas auxiliares

auxiliary tables
tables auxiliaires
столы вспомогательные

mueble bar

bar cabinet
meuble bar
фригобар



_01726 710x440x740

artículos según medida cliente

items as per customers measurements
-
специзделия по размерам клиента



SE99991

armarios

bookcases
armoires
шкафы



01731 930x400x725



01732 930x400x1365



01733 930x400x2035



01741 465x400x725



01744 465x400x725



01742 465x400x1365



01743 465x400x2035

armarios melaminados

melamine bookcases
armoires melamine
шкафы меламина



A231 930x400x710



A232 930x400x1350



A233 930x400x2010



A241 465x400x710



A242 465x400x1350



A243 465x400x2010

juego de costados finales para armarios

set of bookcases endsides
jeu de panneaux latéraux
боковины шкафов



01751 30x430x742



01752 30x430x1382



01753 30x430x2052

tapas

tops
dessus armoires
топы для шкафов



_01761 495x425x17
_01861 *465x425x20



_01762 960x425x17
_01862 *930x425x20



*solo con cuerpos melamina
only melamine bookcase
seulement pour armoires mélaminées
только с корпусом из меламина
_01763 1425x425x17
_01863 *1400x425x20



_01764 1890x425x17
_01864 *1860x425x20

puertas

doors
portes
двери



_01765 2355x425x17
_01865 *2330x425x20



_01766 2820x425x17
_01866 *2790x425x20



_01735 920x20x670



01736 920x20x1310



_01737 920x20x1980



_01735-1 460x20x670



01736-1 460x20x1310



_01737-1 460x20x1980

puertas aluminio / cristal

glass doors with aluminium frame
portes vitrées cadre aluminium
двери алюминий/стекло



archivo

filings
classement
архив



cajoneras metálicas

metallic chest of drawers
caissons métalliques
тумбы мобильные металлические



cajoneras

chest of drawers
éléments auxiliaires
тумбочки

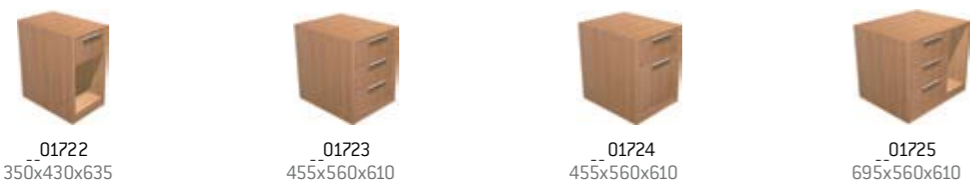

sofás

sofas
sofas
диваны



mostradores

counters
comptoir
стойки-ресепшн



estanterías

wall shelving
etagères murales
стеллажи



componentes de estanterías a pared

components for wall shelving
composants pour étagères murales
составные части для хромированных стеллажей



paneles

wall panels
panneaux muraux
панелирование – стеновые панели



según proyecto
per project
sur demande
по проекту

opciones de superficie surface options | finitions | варианты отделки

ROBLE | OAK (RO)
CHÊNE | ДУБ



ROBLE-NEGRO | OAK-BLACK (NP)
CHÊNE-NOIR | ДУБ-ЧЕРНЫЙ



WENGUÉ | WENGUE (WE)
WENGÉ | ВЕНГЕ

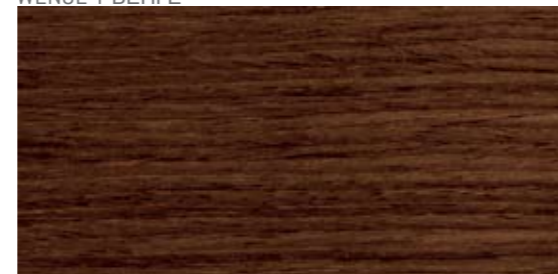

ROBLE-NOGAL | OAK-WALNUT (NA)
CHÊNE-NOYER | ДУБ-ОРЕХ



LACADO BLANCO MATE | MATE WHITE LACQUERED (LB)
BLANC LAQUE MATE | БЕЛЫЙ – ЛАКИРОВАННЫЙ МАТОВЫЙ

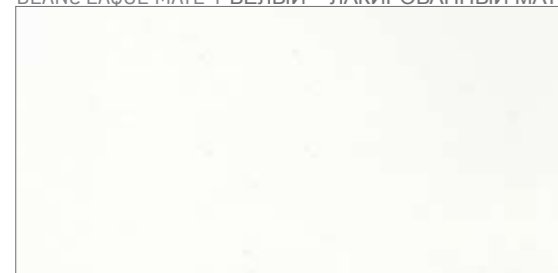

LACADO GRIS PIEDRA | STONE GREY LACQUERED (LG)
GRIS LAQUE MATE | СЕРЫЙ ТОРТОЛА – ЛАКИРОВАННЫЙ МАТОВЫЙ



LACADO ANTRACITA MATE | MATE ANTHRACITE LACQUERED (LA)
ANTHRACITE LAQUE MATE | АНТРАЦИТ – ЛАКИРОВАННЫЙ МАТОВЫЙ



LACADO MARRÓN MATE | MATE BROWN LACQUERED (LM)
MARRON LAQUE MATE | КОРИЧНЕВЫЙ – ЛАКИРОВАННЫЙ МАТОВЫЙ



opciones de estructura armarios melamina structure options | finitions de la structure | варианты отделки каркаса

ALUMINIO | ALUMINIUM (AL)
ALUMINIUM | АЛЮМИНИЙ

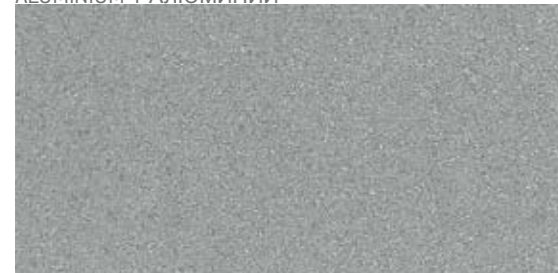

ANTRACITA | ANTHRACITE (AN)
ANTHRACITE | АНТРАЦИТ



Datos técnicos Technical data
Fiche technique | Технические данные

Estructura: Panel atamborado curvo.
Tapas: Tablero aglomerado de 30 mm recubierto con chapas naturales de madera 0,6mm. de espesor y cantos chapados.
Structure: Technical sandwich curved structure
30mm particle board, veneered with 0,6mm thick wooden veneer.
Structure: Panneau rembourré courbe
Plateau: Agglomérée de 30mm d'épaisseur, plaquage bois naturel de 0,6mm d'épaisseur.
Каркас: тамборат закругленной формы
Столешницы: ДСП 30 мм с покрытием натуральным шпоном толщиной 0,6 мм, кромка шпон

Acabado Finish
Finition | отделка

2 capas de fondo poliacrílico y 1 capa de laca de poliuretano.
Conditioner coat, 2 polycrylic base coats and 1 polyurethane finish coat.
2 couches de fond poli-acrylique, 1 couche de fond de laque de poliuréthane.
2 внутренних слоя из полиакрила и 1 слой из полиуретанового лака

Acabado piel página 47
Leather finishes page 47
Finition cuir page 47
варианты отделки кожи стр. 47

confort y estilo

comfort and Style | confort et estile | Комфорт и стиль

Concepto se sustenta en la simplicidad de sus formas, y en la calidad de los materiales utilizados en su fabricación, así como sus acabados. Un diseño minimalista depurado, único en su estética e integrado en el contexto actual de Oficina.

Concept is based in the simplicity of its shapes , the quality of materials used in its manufacturing process and available finishes. A minimalist design, unique in its aesthetic and integrated into every office environment.

Concepto est basé sur la simplicité de la forme, et la qualité des matériaux utilisés dans sa fabrication et de finition. Un design élégant minimaliste, unique dans son esthétique et intégré dans le contexte actuel de l'Office.

Concepto основывается на легкости форм и качестве материалов, используемых при изготовлении и отделке. Минималистический дизайн, уникальный в своем эстетическом выражении интегрируется в современные офисные условия.

concepto
estellesdesign







diversity of combinations and finishes
diversidad de combinaciones y acabados
diversité de combinaisons et de finitions
разнообразие комбинаций и отделки





mesas ejecutivas

executive desks
bureaux semi-directionnels
столы для руководителя



C001800_ 2050x900x750
C001801_ 1850x900x750
C001802_ 1650x900x750
C001803_ 1250x600x750

mesas de juntas

meeting tables
tables de réunion
столы для совещаний



C001820_ 1250x1200x750



C001823_ 1650x1200x750
C001824_ 1850x1200x750
C001821_ 2050x1200x750
C001822_ 2450x1200x750



C001825_ 3250x1200x750
C001826_ 3650x1200x750
C001827_ 4050x1200x750

alas

extensions
retour
столы приставные



C001804_ 600x1225x750

centros

coffee tables
tables basses
столы журнальные



C001745_ 750x700x480



C001746_ 1450x700x480



C099991

artículos según medida cliente

items as per customers measurements
-
специзделия по размерам клиента

faldones

modesty panels
voile de fond
панели передние



_01809 1740x340x20
_01810 1540x340x20
_01811 1340x340x20
_01812 940x340x20



AUX3063_ 800x160x91



AUX7000125 235x140x40

armarios

bookcases
armoires
шкафы



01731_ 930x400x725



01732_ 930x400x1365



01733_ 930x400x2035



01741_ 465x400x725



01744_ 465x400x725



01742_ 465x400x1365



01743_ 465x400x2035

armarios metálicos

metallic bookcases
armoires métalliques
шкафы металлические



01931_ 930x400x710



01932_ 930x400x1350



01933_ 930x400x2010



01941_ 465x400x710



01942_ 465x400x1350



01943_ 465x400x2010

puertas

doors
portes
двери



01735_ 920x20x670



01736_ 920x20x1310



01737_ 920x20x1980



01735-1_ 460x20x670



01736-1_ 460x20x1310



01737-1_ 460x20x1980

puertas aluminio / cristal

glass doors with aluminium frame
portes vitrées cadre aluminio
двери алюминий/стекло



CMP289_ 920x20x670



CMP290_ 920x20x1310



CMP291_ 920x20x1980



CMP294_ 460x20x670



CMP292_ 460x20x1310



CMP293_ 460x20x1980

juego de costados finales para armarios

set of bookcases endsides
jeu de panneaux latéraux
боковины шкафов



01751 30x430x742
01752 30x430x1382
01753 30x430x2052

tapas

tops
dessus armoires
топы для шкафов



01761 495x425x17
01762 960x425x17
01763 1425x425x17
01764 1890x425x17
01765 2355x425x17
01766 2820x425x17



01861 465x425x17
01862 930x425x17
01863 1395x425x17
01864 1860x425x17
01865 2325x425x17
01866 2790x425x17



01961 465x425x12
01962 930x425x12
01963 1395x425x12
01964 1860x425x12
01965 2325x425x12
01966 2790x425x12

solo con cuerpos metálicos / melamina
only for metal / melamine bookcase
seulement pour armoires métalliques / mélaminées
только с корпусом из металла / меламинна

cajoneras

chest of drawers
éléments auxiliaires
тумбочки



01722 350x430x635



01723 455x560x610



01724 455x560x610



01725 695x560x610



01726 710x440x740



01923 420x540x560



01924 420x540x560

cajoneras metálicas

metallic chest of drawers
caissons métalliques
тумбы мобильные металлические

estanterías

wall shelving
etagères murales
стеллажи



01785CR 620x300x2070



01786CR 1180x300x2070



01787CR 1740x300x2070



01788CR 2300x300x2070



01789CR 1120x300x2070



01790CR 2180x300x2070

unidad | unit | unité | единица измерения >> mm

archivo

filings
classement
архив



01749 925x20x665



BST900 890x375



GCP140 890



01749-1 460x20x665



BST400 425x375

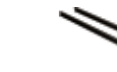

GCP150 425

mostradores

counters
comptoir
стойки-ресепшн



01795 1000x660x1090



01796 2000x660x1090



01797 r=1445x1090



01798 r=1426x1090



AL01799 730x1100



AL01794 730x1100

componentes de estanterías a pared

components for wall shelving
composants pour étagères murales
составные части для хромированных стеллажей



01791CR 3240x300x2070



01792CR 4300x300x2070



CM01780 60x170x2070



CMCR01781 500x300x20



CMCR01782 1000x300x20

unidad | unit | unité | единица измерения >> mm

paneles

wall panels
panneaux muraux
панелирование – стеновые панели



CS99993

según proyecto
per project
sur demande
по проекту

opciones de superficie | surface options | finitions | варианты отделки

ROBLE | OAK (RO)
CHÊNE | ДУБ



ROBLE-NEGRO | OAK-BLACK (NP)
CHÊNE-NOIR | ДУБ-ЧЕРНЫЙ



WENGUÉ | WENGUE (WE)
WENGÉ | ВЕНГЕ



ROBLE-NOGAL | OAK-WALNUT (NA)
CHÊNE-NOYER | ДУБ-ОРЕХ



LACADO BLANCO MATE | MATE WHITE LACQUERED (LB)
BLANC LAQUE MATE | БЕЛЫЙ – ЛАКИРОВАННЫЙ МАТОВЫЙ



LACADO GRIS PIEDRA | STONE GREY LACQUERED (LG)
GRIS LAQUE MATE | СЕРЫЙ ТОРТОЛА – ЛАКИРОВАННЫЙ МАТОВЫЙ



LACADO ANTRACITA MATE | MATE ANTHRACITE LACQUERED (LA)
ANTHRACITE LAQUE MATE | АНТРАЦИТ – ЛАКИРОВАННЫЙ МАТОВЫЙ



LACADO MARRÓN MATE | MATE BROWN LACQUERED (LM)
MARRON LAQUE MATE | КОРИЧНЕВЫЙ – ЛАКИРОВАННЫЙ МАТОВЫЙ



opciones de estructura armario/cajonera

structure options | finitions de la structure | варианты отделки каркаса

METAL MARRÓN | BROWN METAL (MR)
MÉTAL MARRON | КОРИЧНЕВЫЙ МЕТАЛЛ



METAL BLANCO | WHITE METAL (BL)
MÉTAL BLANC | БЕЛЫЙ МЕТАЛЛ

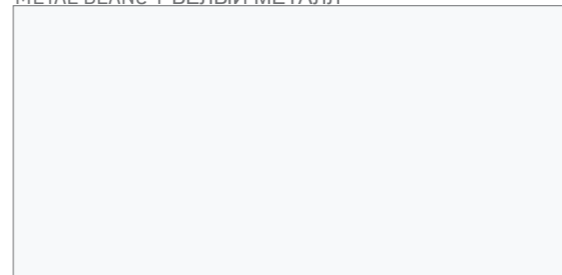

opciones de estructura mesa

structure options | finitions de la structure
варианты отделки каркаса

CROMO BRILLO | BRIGHT CHROME
CHROMÉ BRILLANT | ХРОМ БЛЕСТЯЩИЙ



METAL BLANCO | WHITE METAL (2)
MÉTAL BLANC | БЕЛЫЙ МЕТАЛЛ



Datos técnicos | Technical data

Fiche technique | Технические данные

Tubo de acero de 90x30x2 mm
Tapas: Tablero aglomerado de 30mm recubierto con chapas naturales de madera de 0,6 mm de espesor, cantos chapados.
Structure: 90x30x2mm steel beam
30mm particle board, veneered with 0,6mm thick wooden veneer
Structure: tube d'acier 90x30x2mm
Plateau: Aggloméré de 30mm d'épaisseur, plaquage bois naturel de 0,6mm d'épaisseur.
Стальной профиль 90x30x2 мм.
Столешницы: ДСП 30 мм с покрытием натуральным шпоном толщиной 0,6 мм, кромка шпон

Acabado | Finish

Finition | отделка

tinte hidroalcohólico
2 capas de fondo poliacrílico
1 capa de acabado de laca de poliuretano de alta resistencia
hydroalcoholic dye
2 polyacrylic base coats
1 polyurethane finish coat
vernís a l'alcohol
2 couches de fond poli-acrylique
1 couche de fond de laque de poliuréthane de haute densité
спирторастворимые красители
2 слоя акрилового лака
1 слой износостойчивого полиуретанового лака



To create workplaces according with today's offices environments, Ofifran combines materials, colours, styles and manufacturing techniques, providing an aesthetic craftsmanship in each of our projects.

Para diseñar espacios coherentes con los entornos y oficinas actuales, Ofifran fusiona materiales, colores, estilos y técnicas en la fabricación que proporcionan una estética artesanal en cada uno de sus PROYECTOS.

Pour concevoir des espaces cohérents avec les environnements et les bureaux actuels, Ofifran fusionne matériaux, couleurs, styles et techniques de fabrication ce qui apportent une esthétique artisanale dans chacun de ses PROJETS

Для разработки дизайна пространства в соответствии с современными тенденциями Ofifran использует сочетание материалов и цвета, стилей и передовых технологий в производстве, которые подчеркивают высокую эстетику каждого проекта.



- | | |
|------------------------|----------------------|
| ALGERIA | JORDAN |
| ANDORRA | KAZAHSTAN |
| ANGOLA | KUWAIT |
| ARMENIA | LEBANON |
| AUSTRIA | LETONIA |
| BAHRAIN | LITHUANIA |
| BELGIUM | MAURITANIA |
| BENIN | MEXICO |
| BRITISH VIRGIN ISLANDS | MOROCCO |
| BULGARIA | MOZAMBIQUE |
| CHILE | NETHERLANDS |
| COSTA RICA | POLAND |
| CYPRUS | PORTUGAL |
| CZECH REPUBLIC | QATAR |
| DOMINICAN REPUBLIC | ROMANIA |
| EQUATORIAL GUINEA | RUSSIA |
| FINLAND | SAUDI ARABIA |
| FRANCE | SLOVAKIA |
| GABON | SPAIN |
| GERMANY | SULTANATE OF OMAN |
| GREECE | SWITZERLAND |
| HONG KONG | TUNISIA |
| HUNGARY | TURKEY |
| ICELAND | UCRANIA |
| IRELAND | UNITED ARAB EMIRATES |
| ITALY | UNITED KINGDOM |
| JAPAN | USA |

contract





ray
dorigo design



Dorigo design y Ofifran han concentrado su amplia experiencia en la creación de la familia de sofás y sillones Ray of Light. El sillón Ray aporta un gran confort y un toque elegante en las instalaciones de contract ofreciendo infinitas combinaciones de colores en sus patas y tapizados en su estética.

Dorigo Design and Ofifran have combined their wide experience in creating the family of Armchairs and Sofas called Ray of Light. The armchair Ray brings great comfort and a touch of elegance in every contract installation, providing infinite colour combinations in frame and upholstery.

Dorigo design et Ofifran ont réuni leur vaste expérience pour créer la famille de canapés et de fauteuil Ray of Light. Le fauteuil le Ray offre un grand confort et une touche d'élégance dans les installations de contract et offre une infinité de combinaisons de couleurs pour ses pieds et de revêtements pour son esthétique.

Dorigo design и Ofifran объединили свой богатый опыт для создания серии кресел Ray of Light. Кресло Ray придает комфорт и элегантность в помещениях «contract market», предлагая множество цветовых комбинаций опор и эстетической обивки.

Datos técnicos Technical data
Fiche technique | Технические данные

Patatas madera de haya tintada.
Estructura interna de madera.
Relleno de poliuretano con densidad 60 en el asiento y 30 en el respaldo, indeformable y resistente al fuego Clase1.
Tapizado en piel natural o en piel ecológica cosida.
Armchair.
Wooden legs in tinted Beech.
Internal structure in wood.
Polyurethane foam density 60D in seat and 30D in backrest, undeformable and fire retardant Class 1.
Upholstered in natural leather or sewn ecological leather.
Pieds en hêtre teinté.
Structure interne en bois.
Rembourrage en polyuréthane d'une densité de 60 dans l'assise et de 30 dans le dossier, indéformable et résistant au feu.
Classe 1.
Revêtement en cuir naturel ou en cuir écologique cousu.
кресла
Деревянные опоры - массив бука тонированный
Внутренний каркас из дерева
Набивка из недеформируемого полиуретана плотностью 60D на сиденье и 30D на спинке, обладающего огнестойкостью I класса.
обивка - натуральная кожа или кож. Зам.

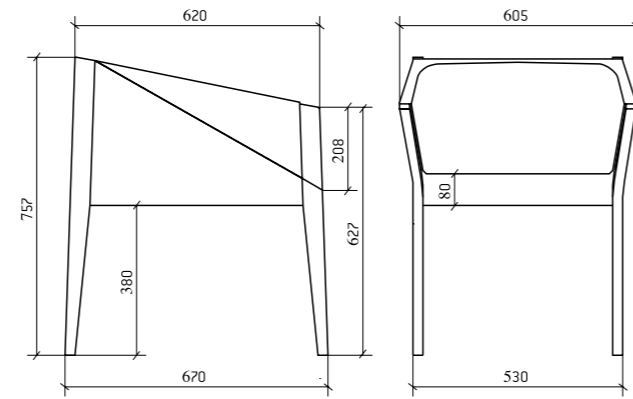

opciones de estructura
structure options | finitions de la structure | варианты отделки каркаса

ROBLE OAK CHÊNE ДУБ	NOGAL ITALIANO ITALIAN WALNUT NOYER ITALIEN ИТАЛЬЯНСКИЙ ОРЕХ	NOGAL WALNUT NOYER ОРЕХ	TEKA OSCURO DARK TEAK TEAK FONCÉ ТЕКА ТЕМНЫЙ	WENGUÉ WENGUE WENGÉ ВЕНГЕ	NOGAL ESPAÑOL SPANISH WALNUT NOYER ESPAGNOL ИСПАНСКИЙ ОРЕХ
NEGRO TINTADO BLACK TINTED TEINTÉ NOIR ТОНИРОВКА ЧЕРНЫМ ЦВЕТОМ	LACADO GRIS PIEDRA STONE GREY LACQUERED GRIS LAQUE MATE СЕРЫЙ ТОРТОЛА – ЛАКИРОВАННЫЙ МАТОВЫЙ	LACADO BLANCO MATE MATE WITHE LACQUERED BLANC LAQUE MATE БЕЛЫЙ – ЛАКИРОВАННЫЙ МАТОВЫЙ	LACADO MARRÓN MATE MATE BROWN LACQUERED MARRON LAQUE MATE КОРИЧНЕВЫЙ – ЛАКИРОВАННЫЙ МАТОВЫЙ	LACADO ANTRACITA MATE MATE ANTHRACITE LACQUERED ANTHRACITE LAQUE MATE АНТРАЦИТ – ЛАКИРОВАННЫЙ МАТОВЫЙ	

opciones de tapizado leather finishes | finitions | варианты обивки

Acabado piel página 47
Leather finishes page 47
Finition cuir page 47
варианты отделки кожи стр. 47









ofifran

calidad

Dentro del Grupo Ofifran, la excelencia en nuestras operaciones significa aumentar la satisfacción de nuestros clientes, nuestra posición en el mercado así como los resultados económicos, mediante la garantía de una mejora continua en la calidad y coste de nuestros procesos, productos y servicios. El despliegue de esta excelencia operacional nos permite satisfacer los compromisos de nuestra Política de Calidad.

quality

Within Ofifran Group, Operational Excellence means increasing our customers' satisfaction, our market position and financial results by ensuring continual quality and cost improvement in our processes, products and services. Deployment of Operational Excellence enables us to meet the commitments within our Quality Policy.

qualité

Dans le groupe Ofifran, l'excellence dans nos opérations signifie augmenter la satisfaction de nos clients, notre positionnement dans le marché et aussi les résultats économiques, par la garantie d'un améliorement continu de la qualité et des coûts de nos processus, produits et services. L'ensemble de moyens de cette excellence opérationnelle nous permet de satisfaire les engagements de notre Politique de Qualité.

КАЧЕСТВО

В своей деятельности группа Ofifran стремится соответствовать требованиям клиента, а также быть конкурентоспособной, гарантируя улучшение соотношения цена-качество самого производства и услуг. Таким образом, деятельность группы Ofifran позволяет выполнять обязательства по качеству нашей продукции.

Ofifran, para la mejora de nuestros productos, se reserva el derecho de anular o modificar, total o parcialmente, sin previo aviso, cualquiera de los modelos, colores, formatos, referencias y especificaciones técnicas contenidas en este catálogo. Debido a la técnica de impresión, pueden existir diferencias de color entre el real y el reproducido en este catálogo.

Ofifran, in order to improve our products, reserves the right to delete or amend, either totally or partially, without notice, any of designs, colours, shapes, references and technical specifications included in this catalogue. Due to the printing technique, it may exist colour differences between the real colour and the reproduced one in this catalogue.

Ofifran, pour améliorer nos produits, se réserve le droit d'annuler ou modifier, totalement ou partiellement, sans aucun préavis, les modèles, les finitions, les dimensions, les références et les spécifications techniques incluses dans ce catalogue. En raison de l'impression, il peut exister des différences de couleur entre le réel et le reproduit dans ce catalogue.

Для улучшения качества продукции Ofifran оставляет за собой право без предупреждения исключить или модифицировать полностью или частично любую модель, цвет, формат, артикулы или техническую спецификацию, находящуюся в каталоге. В зависимости от техники печати могут иметь место различия в цвете между оригиналом и его изображением в каталоге.





Pol. Ind. Gutenberg
La Pobla de Vallbona · 46185 Valencia (Spain)
T. +34 961662215 · F. +34 961661539
rus-cis@ofifran.com
www.ofifran.ru

